

Article number: 20343250M1280KR  
Description: E+G Levelling foot  
GN 343.2-50-M12-80-KR  
Note: 0

## Measures

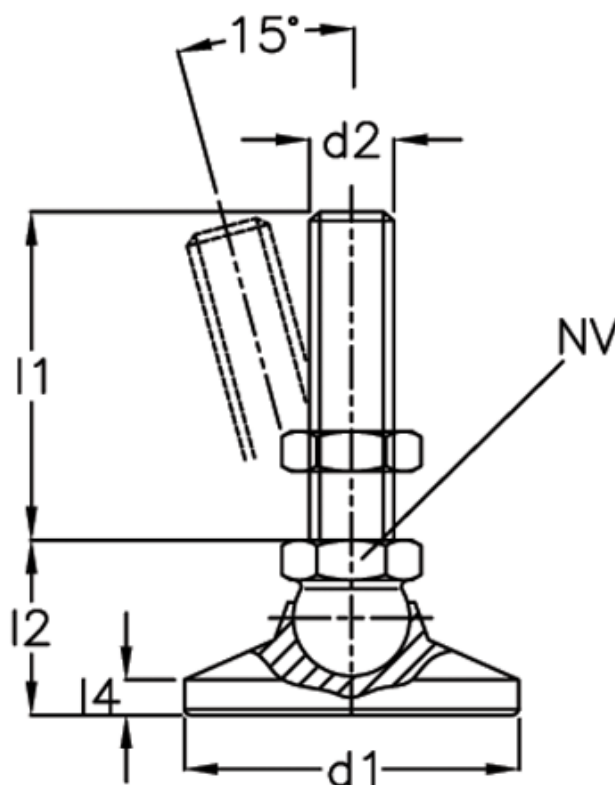

$d1 = 50$   
 $d2 = M12$   
 $l1 = 80$   
 $l2 = -$   
 $l3 = 29.5$   
 $l4 = -$   
 $l5 = 8.5$   
 $NV = 17$

Static load = 30  
Weight in (g) = 255